

Yuasa NP batteries are the trusted choice around the world for standby power in applications where system integrity is paramount. Yuasa NP batteries incorporate high energy density and thick lead calcium grids for an extended battery life. Offering superb recovery from deep discharge, these multipurpose batteries are ideal for float or cyclic use.

Yuasa NP's unique construction and sealing technique ensures no electrolyte leakage from case or terminals, providing complete peace of mind. All NP batteries utilise Yuasa's unique electrolyte suspension system as well as the very latest oxygen recombination technology to effectively eliminate the need for watering during normal use.

- ✓ Sealed construction with pressure relief system
- ✓ Operation in any orientation (except in an inverted position)
- ✓ Heavy duty grids
- ✓ Low self discharge
- ✓ Flame Retardant container material
- ✓ 98% recyclable

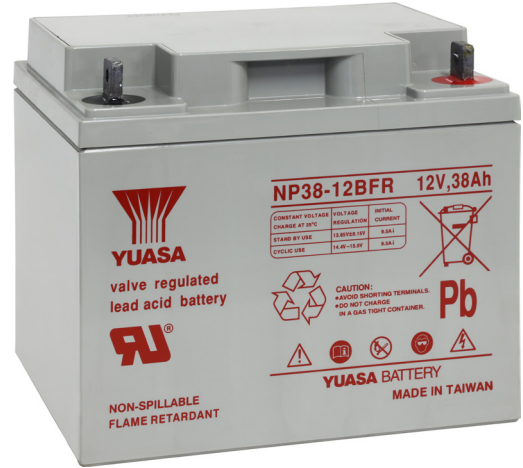

### Performance Specifications

Nominal Voltage	12V
Rated Capacity at 25°C	40.6Ah (20 hour, 10.5V) 38.9Ah (10 hour, 10.5V) 34.1Ah (5 hour, 10.5V) 26.6Ah (1 hour, 10.5V)
Internal Resistance at 25°C	Approx. 6.8mΩ
Maximum Discharge Current	228A (5 sec.)
Maximum Charge Current	9.5A
Charge Voltage	Float charge at 25°C: 13.65V±0.15V Float charge voltage temperature correction factor from standard 25°C: -3mV/°C/Cell Cyclic charge at 25°C: 14.4V~15.0V Cyclic charge voltage temperature correction factor from standard 25°C: -4mV/°C/Cell
Operating Temperature Range	Discharge: -15°C~45°C Charge: -15°C~45°C Storage: -15°C~45°C
Design life at 25°C	3-5 years
Storage	Batteries can be stored for up to 6 months at 25°C after which recharging is recommended. For higher temperatures the time interval will be shorter.

### Physical Specifications

Dimensions	Length: 197±2mm Width: 165±2mm Container Height: 170±2mm Overall Height: 170±2mm
Terminal Type	M5 Bolt, Torque 2.0~3.0Nm (20-30kgf.cm)
Weight	Approx. 13.2kg
Container Material	A.B.S. (Flame Class UL94V-0)

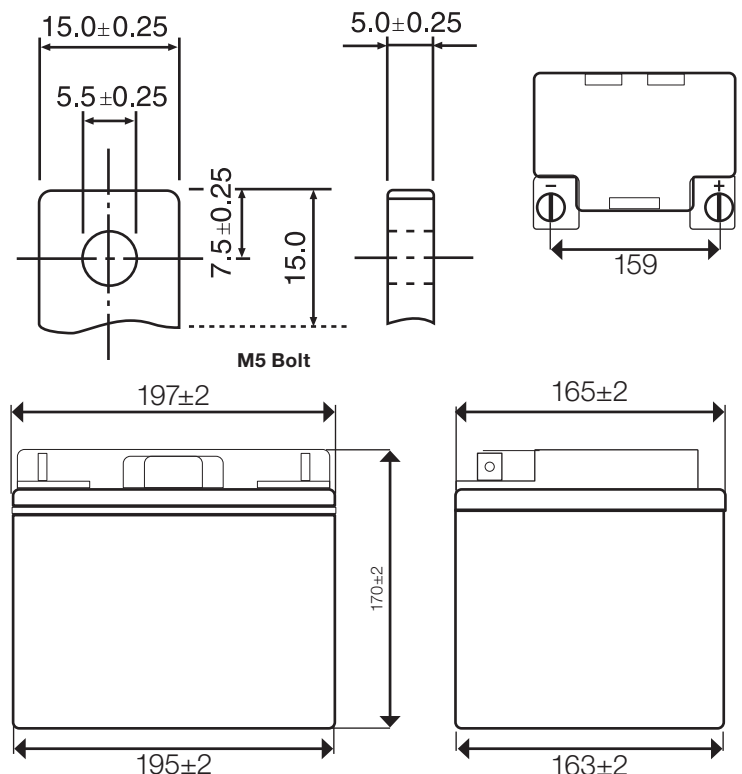

## DISCHARGE CHARACTERISTICS

Discharge Characteristics Curves at 25°C

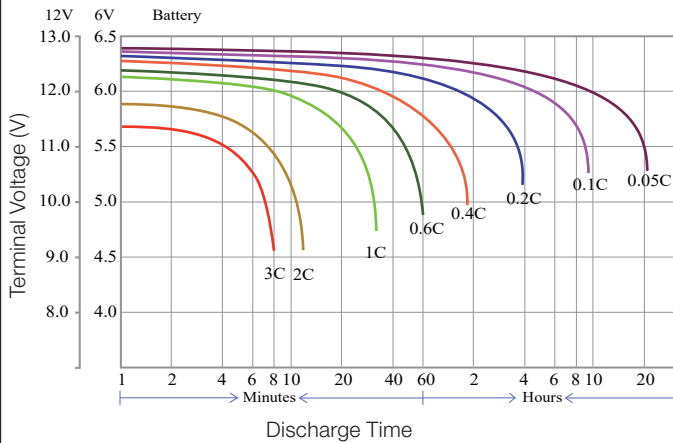

## CHARGE CHARACTERISTICS

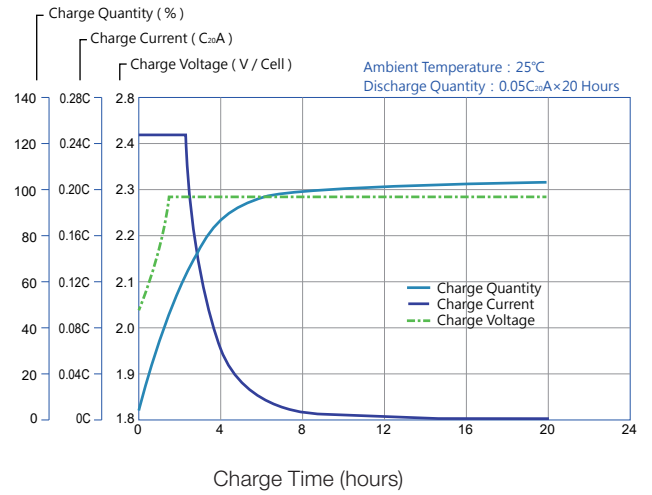

## TEMPERATURE EFFECTS IN RELATION TO BATTERY CAPACITY

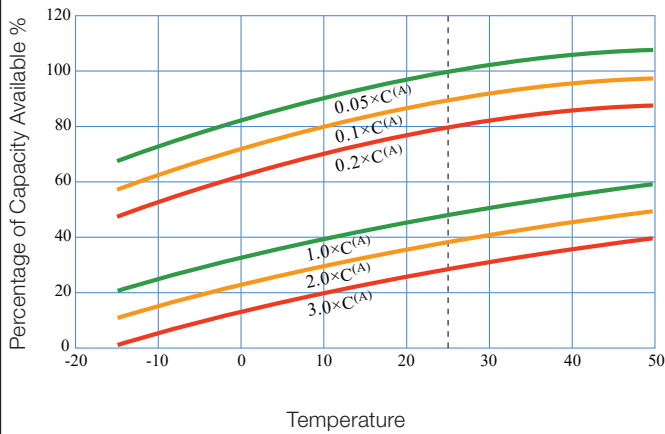

## FLOAT SERVICE LIFE

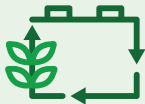
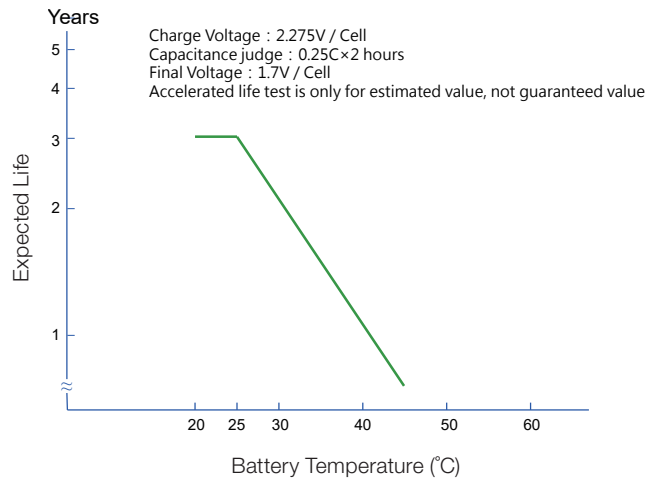

Make a positive change

This battery is 98% recyclable. Help create a cleaner planet, return your used battery to the original place of purchase or your nearest Century Yuasa approved Battery Recycling Centre.

You can find your nearest recycling centre:



1300 650 702  
recyclemybattery.com.au



0800 93 93 93  
recyclemybattery.co.nz

For more information contact a Yuasa battery specialist:

Australia: 49-65 Cobalt Street | Carole Park, QLD 4300 | T: 1300 362 287 | [yuasabatteries.com.au](http://yuasabatteries.com.au)

New Zealand: 259 Church Street | Onehunga, Auckland 1061 | T: 0800 93 93 93 | [yuasabatteries.co.nz](http://yuasabatteries.co.nz)