

Yuasa NP batteries are the trusted choice around the world for standby power in applications where system integrity is paramount. Yuasa NP batteries incorporate high energy density and thick lead calcium grids for an extended battery life. Offering superb recovery from deep discharge, these multipurpose batteries are ideal for float or cyclic use.

Yuasa NP's unique construction and sealing technique ensures no electrolyte leakage from case or terminals, providing complete peace of mind. All NP batteries utilise Yuasa's unique electrolyte suspension system as well as the very latest oxygen recombination technology to effectively eliminate the need for watering during normal use.

- ✓ Sealed construction with pressure relief system
- ✓ Operation in any orientation (except in an inverted position)
- ✓ Heavy duty grids
- ✓ Low self discharge
- ✓ Flame Retardant container material
- ✓ 98% recyclable



Performance Specifications

Nominal Voltage	6V
Rated Capacity at 25°C	7Ah (20 hour, 5.25V)
	6.4Ah (10 hour, 5.25V)
	6.15Ah (5 hour, 5.25V)
	4.84Ah (1 hour, 5.25V)
Internal Resistance at 25°C	Approx. 10.5mΩ
Maximum Discharge Current	105A (5 sec.)
Maximum Charge Current	1.75A
Charge Voltage	Float charge at 25°C: 6.83V±0.08V Float charge voltage temperature correction factor from standard 25°C: -3mV/°C/Cell
	Cyclic charge at 25°C: 7.2V~7.5V Cyclic charge voltage temperature correction factor from standard 25°C: -4mV/°C/Cell
Operating Temperature Range	Discharge: -15°C~45°C Charge: -15°C~45°C Storage: -15°C~45°C
Design life at 25°C	3-5 years
Storage	Batteries can be stored for up to 6 months at 25°C after which recharging is recommended. For higher temperatures the time interval will be shorter.

Physical Specifications

Dimensions	Length:	151±2mm
	Width:	34±1mm
	Container Height:	94±1mm
	Overall Height:	97.5±2mm
Terminal Type	Faston Tab 187 (4.75mm wide)	
Weight	Approx. 1.3kg	
Container Material	A.B.S. (Flame Class UL94V-0)	

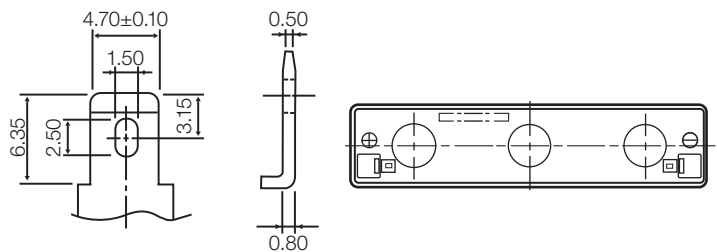

Faston tab : 187 (Standards)

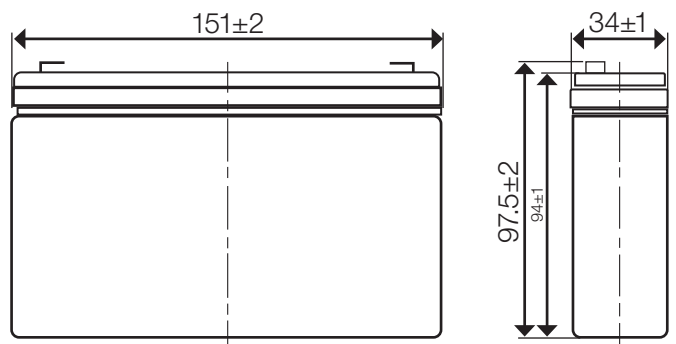

DISCHARGE CHARACTERISTICS

Discharge Characteristics Curves at 25°C

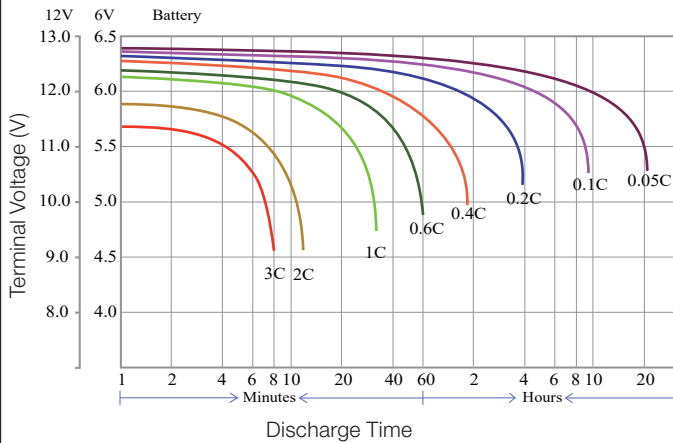

CHARGE CHARACTERISTICS

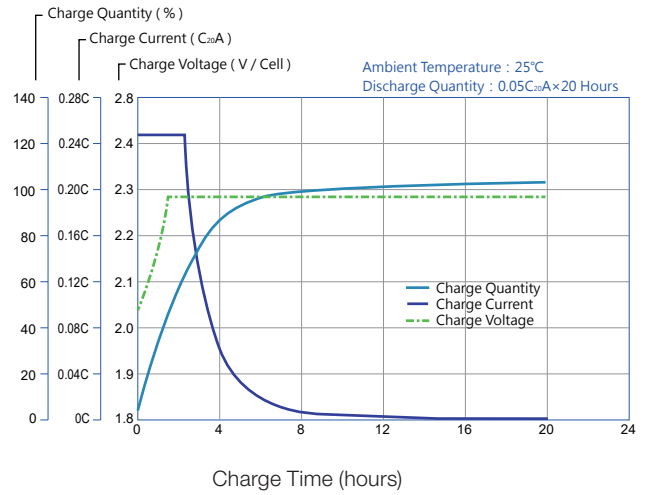

TEMPERATURE EFFECTS IN RELATION TO BATTERY CAPACITY

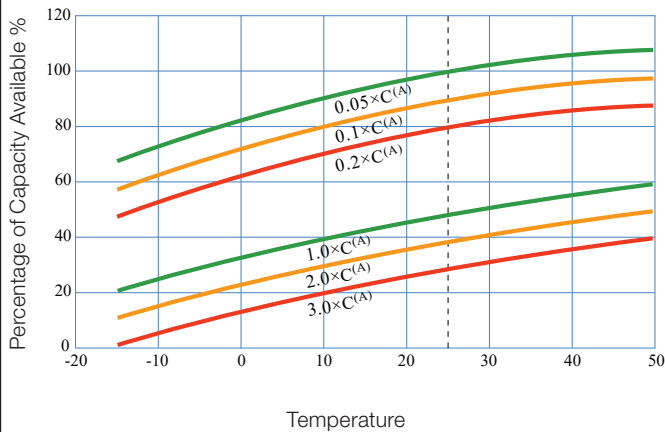

FLOAT SERVICE LIFE

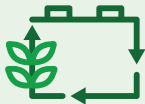
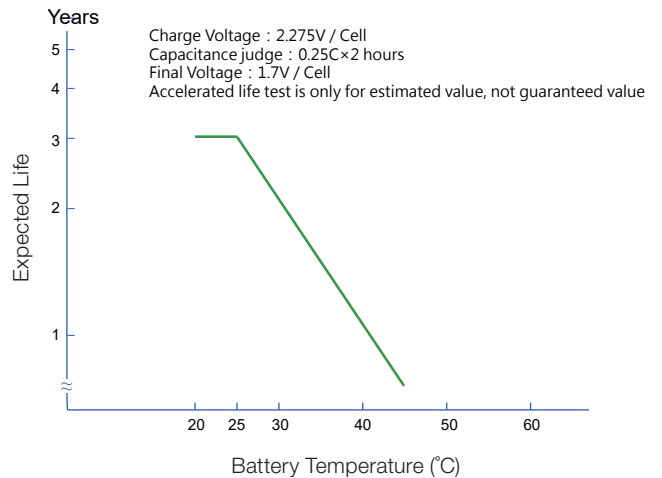

Make a positive change

This battery is 98% recyclable. Help create a cleaner planet, return your used battery to the original place of purchase or your nearest Century Yuasa approved Battery Recycling Centre.

You can find your nearest recycling centre:



1300 650 702
recyclemybattery.com.au



0800 93 93 93
recyclemybattery.co.nz

For more information contact a Yuasa battery specialist:

Australia: 49-65 Cobalt Street | Carole Park, QLD 4300 | T: 1300 362 287 | yuasabatteries.com.au

New Zealand: 259 Church Street | Onehunga, Auckland 1061 | T: 0800 93 93 93 | yuasabatteries.co.nz